

# Wall-Mount Sink INSTALLATION INSTRUCTIONS

---

*Swiss Madison*<sup>®</sup>  
well made forever

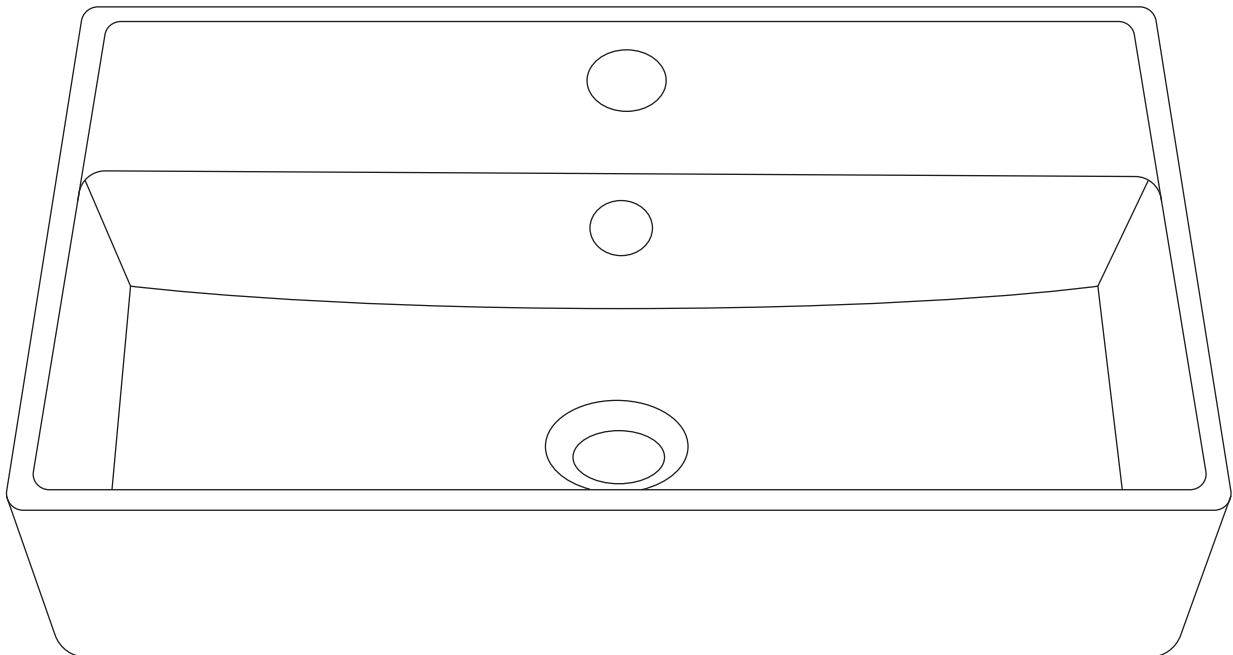

@SwissMadison  
#WellMadeForever





## PRIOR TO INSTALLATION:

- Inspect sink to ensure no damages have occurred while in shipping.
- Observe all plumbing and building codes in accordance with your state and local requirements.
- All dimensions are nominal! Be sure to measure your sink prior to installation.
- The step-by-step guidelines in the installation instructions are a general reference. Should there be any discrepancies, Swiss Madison cannot be held liable. It is recommended to install all Swiss Madison products by hiring a licensed professional.
- Read installation and maintenance instructions thoroughly before installing. Be sure to use proper tools and always wear proper personal safety accessories for your protection.
- Two people are recommended to handle and install this product as it is fragile.
- These fixings are suitable for solid walls only. Plasterboard or stud walls may require specialist fixings (not supplied).
- Care should be taken when drilling walls and floors to avoid any concealed wires or pipes.

If you have any questions or concerns please contact us:

1-434-623-4766

[info@swissmadison.com](mailto:info@swissmadison.com)

## SUGGESTED TOOLS & MATERIALS:



Safety Glasses



Drill



Pencil

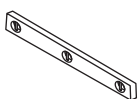

Level

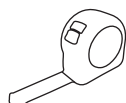

Tape Measure

## INCLUDED PARTS:

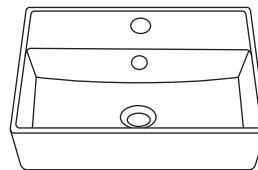

Wall-Mount Sink

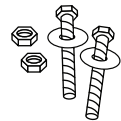

Bolts

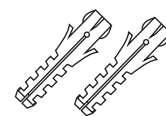

Anchors

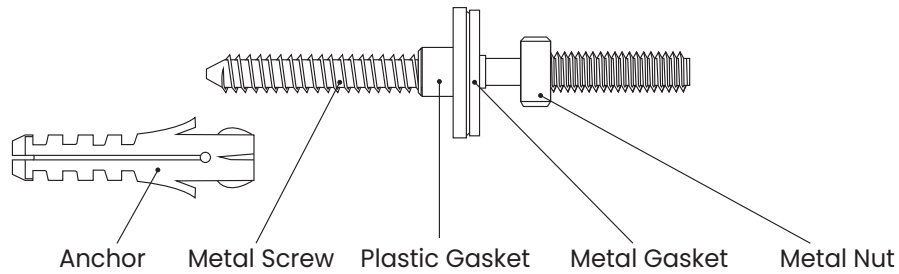

1. Drill two holes in the required position on the wall using a 14 mm masonry drill bit, to a depth of 75 mm.

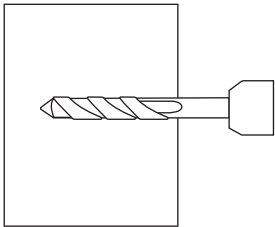

2. Push an anchor into each hole.

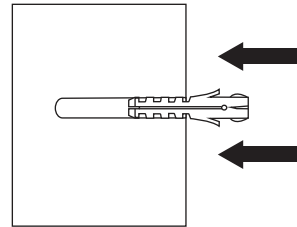

3. Screw a fixing bolt into each fixing plug using a 8 mm spanner until the spanner contacts the wall.

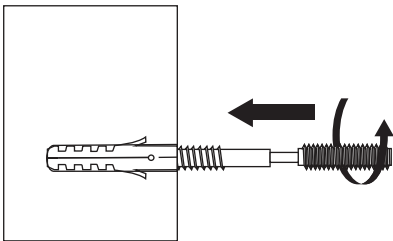

4. Place the basin in position against the wall. Locating the fixing bolts through the holes in the rear of the basin. Push a plastic washer followed by a metal washer, onto each fixing bolt.

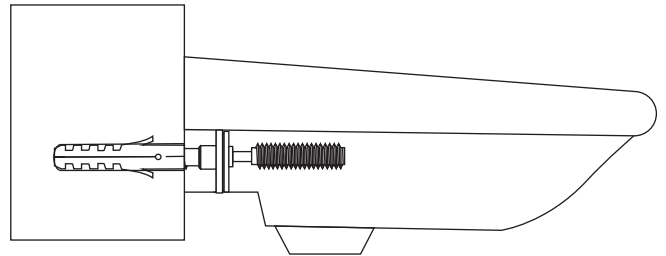

5. Screw metal nut onto each fixing bolt to secure the basin. Do not overtighten, as this may damage the ceramic.

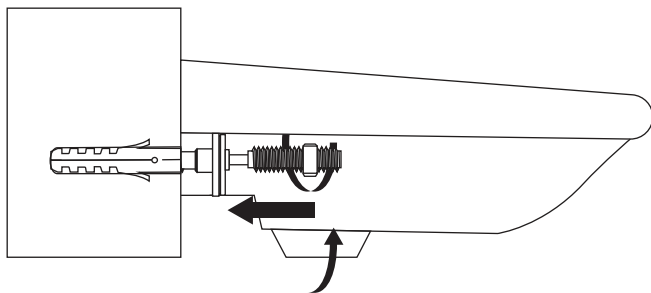

6. Ensure sink is secure, tighten bolts if necessary. Install faucet and drain using manufacturer's instructions. Connect to water supply and check for leaks..

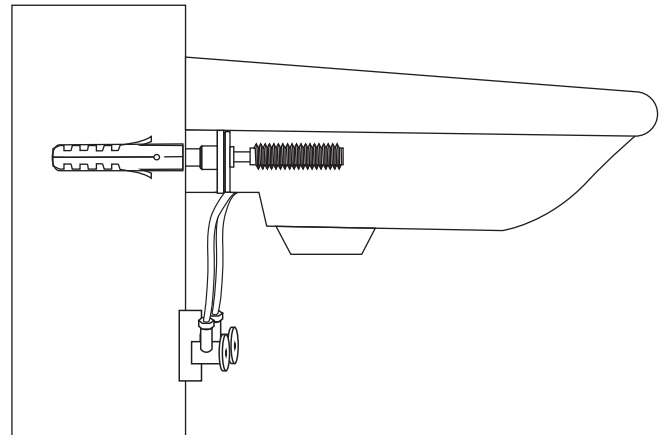

## HALF PEDESTAL WALL-MOUNT SHROUD INSTALLATION:

1. Slide shroud into place, then mark location of holes located on both sides of the shroud.

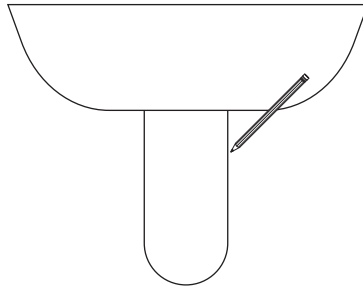

2. Pre-drill into wall and install anchors.

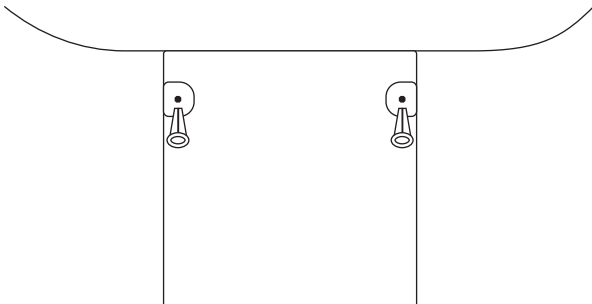

3. Slide shroud into place and secure using same steps as when mounting the sink. Use cover caps to hide hardware. Do not overtighten, it may crack the ceramic.

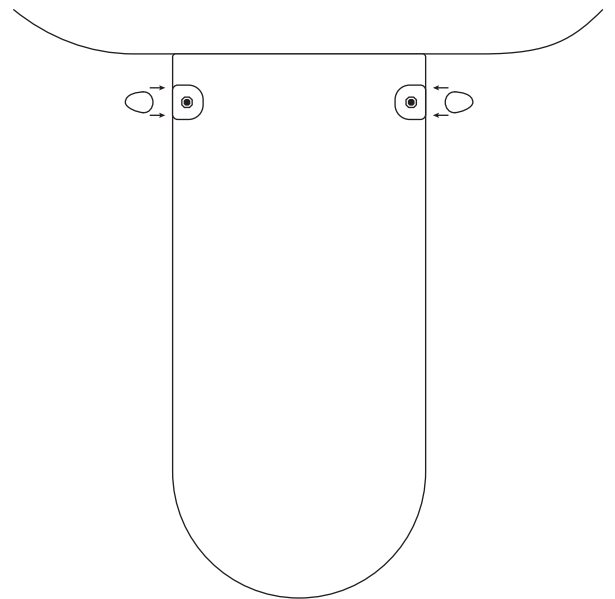



1-434-MADISON

(623-4766)

19 Stults Road

Dayton, NJ 08810

[www.swissmadison.com](http://www.swissmadison.com)

## ONE YEAR LIMITED WARRANTY

Swiss Madison® products are made with quality materials and excellent craftsmanship to provide our customers with beautiful, durable, long-lasting products. Should there be any defects in materials or craftsmanship under regular use that are discovered within the first year of installation, Swiss Madison® will provide replacement parts at no charge, or at its discretion, replace any product or part of the product that is deemed defective, under normal installation, use, service or maintenance. This warranty applies only to the original purchaser. Proof of purchase will be required in the instance of a claim.

Swiss Madison® recommends all installations of Swiss Madison® products to be conducted by a licensed, professional plumber or contractor. Swiss Madison® will not be held responsible for any damage or product failure due to improper installation, misuse, or failure to utilize a licensed professional for installation. Swiss Madison® is not responsible for any installation or removal costs.

### This One Year Limited Warranty Will Be Voided If:

- The installation recommendations were not followed by the installer
- The product has been moved from its initial place of installation
- The product has in any way been modified from its packaged state
- The product has been subjected to improper maintenance, abuse, misuse, excessive use of chemicals, accidents, or other damages, etc.

Swiss Madison® makes no implication that its products comply with any local building or plumbing codes. It is the consumer's responsibility and obligation to determine local code compliance prior to and during installation. This warranty extends only to the original purchaser and first consumer.

Swiss Madison® is not responsible for any special, incidental or consequential damages associated with the installation, replacement, return or use of the original purchaser's product. This includes, but is not limited to: freight costs, labor, travel time, lost profit, home damages and other contingent liabilities and costs (including, without limitation, costs associated with 'professionals' or 'experts', investigations, audits, analyses, attorneys and any other professional/hired services).

The Swiss Madison® warranty is a comprehensive and explicit limit of liability. All items not disclosed within the warranty are not addressable within the responsibility of Swiss Madison®. Certain states have variances regarding implied warranties; in those situations, we remain fully compliant.

**If you have any questions or concerns, please contact us directly at  
1-434-MADISON (623-4766)**

**⚠ WARNING:** Contents of your order may contain sharp and possibly other harmful pieces and may cause hazard to children and adults. Swiss Madison® is not responsible in any way for personal damages.